

Assembly & fitting guide

Aerial with 'F' Balun

DMX10-F



1. Fit reflector sections to aerial boom

Loosen the clamp wing nut but do not remove. Insert both reflector sections as shown. Ensure locating lugs on the clamp fit into the mating holes in reflector booms. Tighten the wing nut securely. Fit plastic stabilising straps to each reflector.

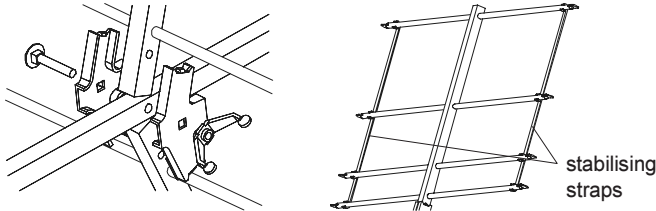

2. Position elements

Rotate and snap the X-shaped director elements into a vertical position as shown.

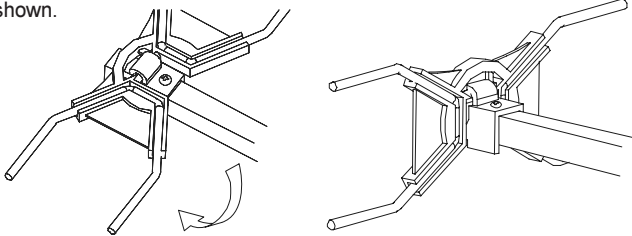

3. Main mast/boom clamp

Join the two main boom sections with the plastic plugs at the front and rear ends of the aerial. Loosen but do not remove the wing nut on the boom coupler. Join the two uncapped boom ends as shown ensuring that the ends are as close together as possible (allowing room for the coupler bolt). Tighten the wing nut securely.

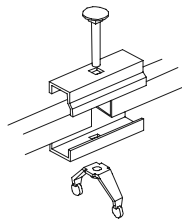

4. Fit coaxial cable and screw-on 'F' plug

Push the cable through the waterproofing sleeve before fitting the plug. Prepare the cable end and fit the screw-on 'F' plug as shown below. (The inner wire of the cable should extend slightly beyond the end of plug.) Offer up the plug to the socket on the aerial housing and tighten gently (11 mm spanner). **Do not leave the plug finger-tight as this may lead to unreliable reception.** Slide the waterproofing sleeve into position over the lip on the aerial housing.

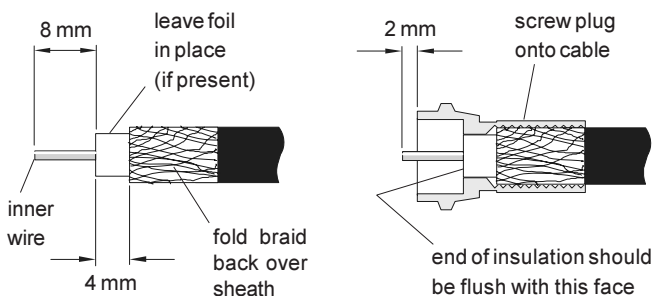

5. Fit mounting cradle to aerial

Loosen and spread the clamps on the pre-assembled cradle. Position the cradle on the booms at the balance point of the aerial as shown and tighten the wing nuts. The diagram shows the aerial horizontally polarised. For vertical polarisation rotate the cradle through 90° in the mast clamp.

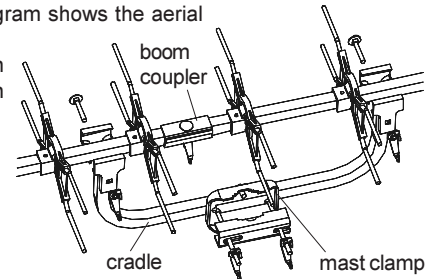

6. Fit aerial to a mast

Slide the mast clamp over a suitable mast 1¼" – 1½" (32-38 mm) diameter and tighten the wing nuts. To tilt the aerial loosen the clamp screws, set position and re-tighten.

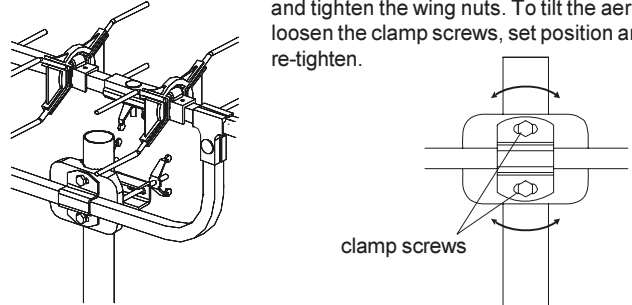

7. Recommended cable route

For best aerial performance the cable should be routed as shown and secured with pvc tape (not supplied). The cable should not touch the aerial boom.

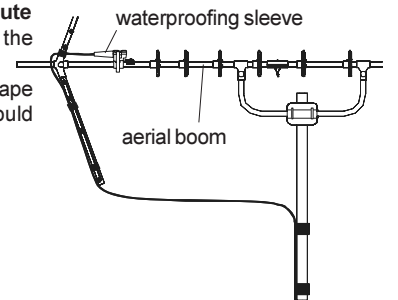

Kit Contents

- 1 - Aerial boom with arrow plate attached.
- 1 - Aerial boom elements only.
- 1 - Dipole assembly.
- 4 - Plastic reflector straps
- 1 - Cradle and mast clamp.
- 2 - Reflector sections.
- 1 - F-type plug.

Safety

Working at height - carry out work outdoors at height only if you are competent in the use of ladders and related access equipment. Always work safely within your own limitations, ensuring that all equipment used is appropriate and is in good condition.

Further advice may be downloaded from:
www.blake-uk.com/downloads on the following:

- reception problems
- fitting coaxial connectors
- distributing TV signals around the home
- general recommendations

Reception Advice Services

BBC Reception Advice 08700 100123
 e-mail: reception@bbc.co.uk
 web: www.bbc.co.uk/reception
 Ofcom Engineering Information
 web: www.ofcom.org.uk/static/reception_advice/index.asp